

LA SERIES

Laser Collimated Beam Sensor

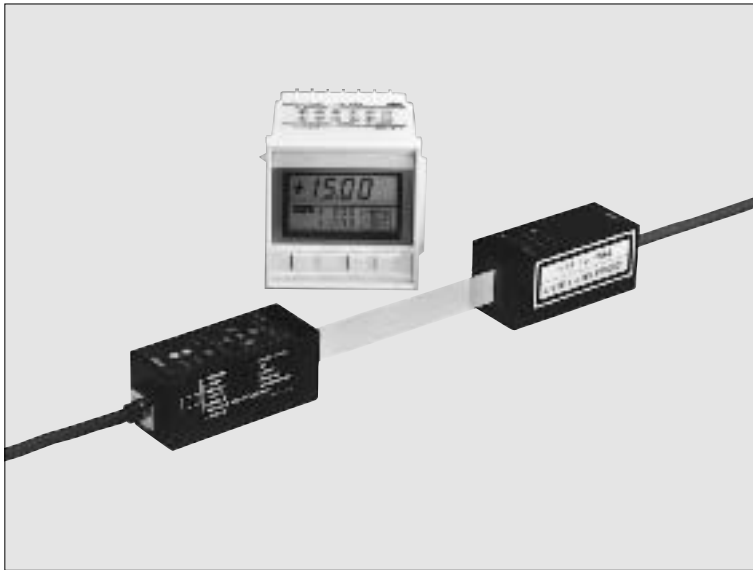

'Class 1' laser beam sensor safe for your eyes



Safe laser beam

This laser collimated beam sensor conforms to the Class 1 laser stipulated in IEC Publication 825 and JIS C 6802-1997. Hence, safety measures such as protective gear are not necessary.

Precise sensing in wide area

Sensing area: 15×500 mm
 0.591×19.685 in
 Minimum sensing object: $\phi 0.1$ mm
 $\phi 0.004$ in
 Repeatability: $10 \mu\text{m}$ 0.394 mil or less

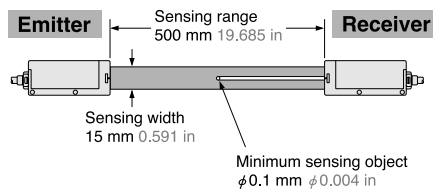

Easy laser beam alignment

Four monitoring LEDs help you to easily align the emitter and the receiver.

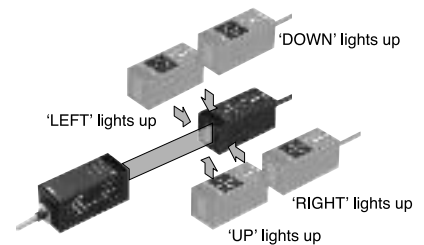

Receiver front face



The monitoring system checks whether the incident beam falls evenly on all the four receiving elements in the receiver window.

Versatile mounting

The side view attachment (optional) enables versatile mounting styles.

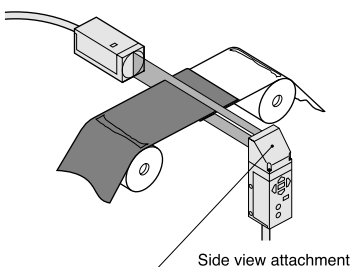

FDA Class I type LA-511

LA-511 conforms to FDA Class I. It is approved for use in U.S.A. by FDA.

APPLICATIONS

Accurate positioning of orientation flat

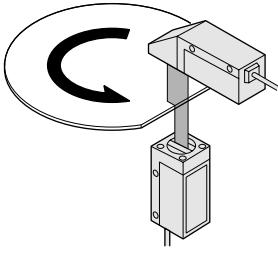

Detecting cathode ray tube

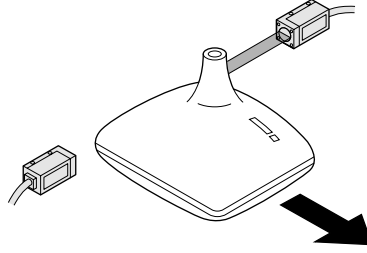

Detecting tablet displaced from pocket

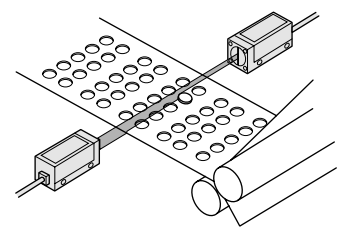

Counting number of O-rings

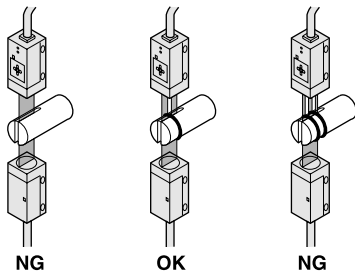

Positioning gear on polishing machine

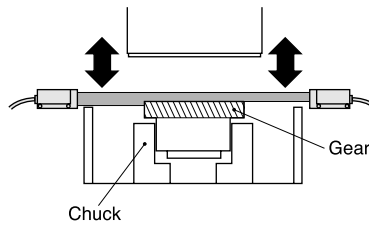

Attitude of chip component

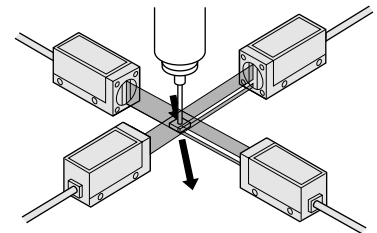

Convenient laser sensor controller LA-C1

• **Simple digital setting**

Fine adjustment can be easily done using the actual object while observing the digital display.

• **Large 3 1/2 digit display**

Easily visible 10 mm 0.394 in letter height display.

• **Auto-reference function**

The set values can be automatically compensated for a change in the reference value by using an external signal.

• **Two types of operation modes**

- ① Hysteresis mode
- ② Window comparator mode



Operation theory

- The semiconductor laser diode and an advanced optical system realize an ideal collimated beam.

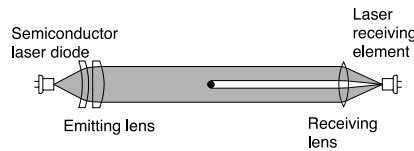

- The high precision APC circuit maintains constant laser beam output power.

The APC (Automatic Power Control) circuit maintains stable emission strength by a feedback technique. A uniform emission level is maintained in spite of temperature drift and/or supply voltage change.

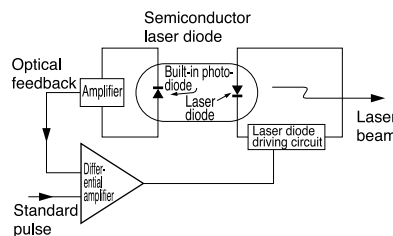

High accuracy applications

- The sensor can be used for various applications due to its collimated laser beam.

Positioning

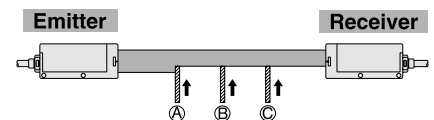

Detection at same degree of intrusion at any position (A, B or C) within the sensing range.

Presence detection

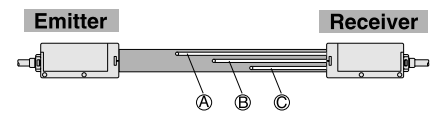

The path position of the sensing object need not be fixed.

Width discrimination

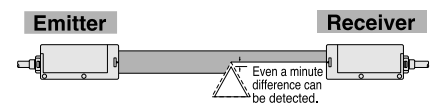

Even a minute difference can be reliably detected since the difference in the beam interruption is projected, as it is, on the receiving section.

Detecting amount of laser beam



Its wide laser beam senses the total object.

ORDER GUIDE

Laser collimated beam sensors

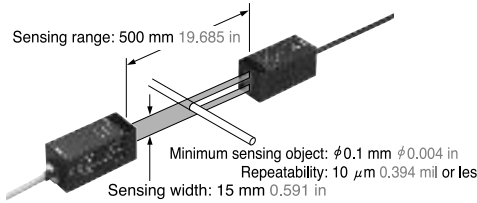
Type	Appearance	Model No.	Conforming standard	Output
Class 1 type	 <p>Sensing range: 500 mm 19.685 in</p> <p>Minimum sensing object: $\phi 0.1$ mm $\phi 0.004$ in Repeatability: 10 μm 0.394 mil or less</p> <p>Sensing width: 15 mm 0.591 in</p> <p>Emitting element: Infrared semiconductor laser diode (Class 1)</p>	LA-510	IEC and JIS standards	NPN open-collector transistor (Comparative output) Analog voltage • Output voltage: 1 to 5 V
		LA-511	FDA standard	

OPTIONS

Designation	Model No.	Description	
Side view attachment (Note 1)	LA-SV1	Versatile mounting is possible as the laser beam can be bent at a right angle. • Sensing range: 500 mm 19.685 in • Minimum sensing object: $\phi 0.1$ mm $\phi 0.004$ in • Repeatability: 20 μ m 0.787 mil or less	
Digital panel controller (Note 2)	CA2-T2	NPN open-collector transistor	This is a very small controller which allows two independent threshold level settings. • Supply voltage: 24 V DC $\pm 10\%$ • No. of inputs: 1 No. (sensor input) • Input range: 1 to 5 V DC • Main functions: Threshold level setting function, zero-adjust function, scale setting function, hysteresis setting function, start / hold function, auto-reference function, power supply ON-delay function, etc.

Notes: 1) Mount **LA-SV1** on either the emitter or the receiver. If it is mounted on both sides, the monitor LEDs may not light off perfectly.
 2) For further details, refer to the ultra-compact digital panel controller **CA2** series.

Accessory

- **MS-LA1** (Sensor mounting bracket)

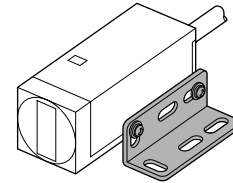

Set of two L-shaped brackets and four M4 (length 8 mm 0.315 in) screws with washers.

Side view attachment

- **LA-SV1**

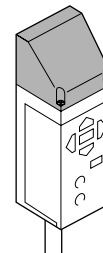

Two M3 (length 10 mm 0.394 in) screws with washers are attached.

Digital panel controller

- **CA2** series



SPECIFICATIONS

Laser collimated beam sensors

Item	Type	Class 1 type	
	Conforming standard	IEC and JIS standards	FDA standard
Model No.		LA-510	LA-511
Sensing width		15 mm 0.591 in	
Sensing range		500 mm 19.685 in	
Min. sensing object		φ0.1 mm φ0.004 in opaque object	
Repeatability		10 μm 0.394 mil or less	
Supply voltage		12 to 24 V DC ± 10 % Ripple P-P 10 % or less	
Current consumption		Emitter: 35 mA or less, Receiver: 25 mA or less	
Comparative output		NPN open-collector transistor • Maximum sink current: 100 mA • Applied voltage: 30 V DC or less (between comparative output and 0 V) • Residual voltage: 1 V or less (at 100 mA sink current) 0.4 V or less (at 16 mA sink current)	
	Utilization category	DC-12 or DC-13	
	Response time	0.5 ms or less	
	Output operation	ON when the incident beam amount is less than the threshold level	
	Short-circuit protection	Incorporated	
Analog output		Analog voltage • Output voltage: 1 V (Darkest) to 5 V (Lightest) • Output impedance: 75 Ω	
	Slew rate	8 V/ms or more	
	Temperature characteristics	Within ± 0.1 % F.S. / °C (with respect to sensing range at ambient temperature + 20 °C + 68 °F)	
Remote interlock input		Laser is emitted when it is connected to 0 V, but not emitted when connected to + V or kept open	
Indicators	Operation	Red LED (lights up when the comparative output is ON)	
	Laser emission warning	Red LED (lights up when laser is being emitted)	
	Stable incident beam	Green LED (lights up under the stable light received condition)	
	Laser beam alignment	Yellow LED × 4 (light up when laser beam is misaligned)	
Adjusters	Threshold level	Adjustment of threshold level for the comparative output, 18-turn endless adjuster	
	Span	Adjustment of span for the analog voltage output, 18-turn endless adjuster	
Environmental resistance	Pollution degree	3 (Industrial environment)	
	Ambient temperature	0 to + 50 °C + 32 to + 122 °F (No dew condensation), Storage: - 20 to + 70 °C - 4 to + 158 °F	
	Ambient humidity	35 to 85 % RH, Storage: 35 to 85 % RH	
	Ambient illuminance	Sunlight: 10,000 lx at the light-receiving face, Incandescent light: 10,000 lx at the light-receiving face	
	EMC	EN 50081-2, EN 61000-6-2	
	Insulation resistance	20 MΩ, or more, with 250 V DC megger between all supply terminals connected together and enclosure	
	Vibration resistance	10 to 55 Hz frequency, 1.5 mm 0.059 in amplitude in X, Y and Z directions for two hours each	
Shock resistance	500 m/s ² acceleration (50 G approx.) in X, Y and Z directions for three times each		
Emitting element		Infrared semiconductor laser diode (Maximum output: 1.7 mW, Peak emission wavelength: 780 nm 0.031 mil)	
Enclosure earthing		Capacitor earth	
Material		Enclosure: Die-cast zinc alloy, Top cover: PPO, Front protection cover: Glass	
Cable		0.2 mm ² 5-core (emitter: 4-core) shielded cable, 3 m 9.843 ft long	
Cable extension (Note)		Extension up to total 50 m 164.042 ft is possible, for both emitter and receiver, with 0.3 mm ² , or more, cable. (Synchronization wire cannot be extended.)	
Weight		Emitter: 290 g approx., Receiver: 280 g approx.	
Accessories		MS-LA1 (Sensor mounting bracket): 1 set for emitter and receiver Adjusting screwdriver: 1 pc. Crimp contact: 2 pcs. Class 1 identification label: 1 pc. (LA-510 only) Inspection slip: 1 pc. (LA-511 only)	

Note: **LA-510** and **LA-511** are CE conformity product complying with EMC Directive. The harmonized standard with regard to immunity that applies to this product is EN61000-6-2 and the following conditions must be met to conform to that standard.

Conditions

- This sensor should be connected less than 10 m 32.808 ft from the power supply.
 - The signal line to connect with this sensor should be less than 30 m 98.425 ft.
- The EN 50082-2 that previously applied to the products for conforming to EMC Directive was replaced by EN 61000-6-2 starting April 1 st, 2002.

I/O CIRCUIT AND WIRING DIAGRAMS

Laser collimated beam sensor

I/O circuit diagram

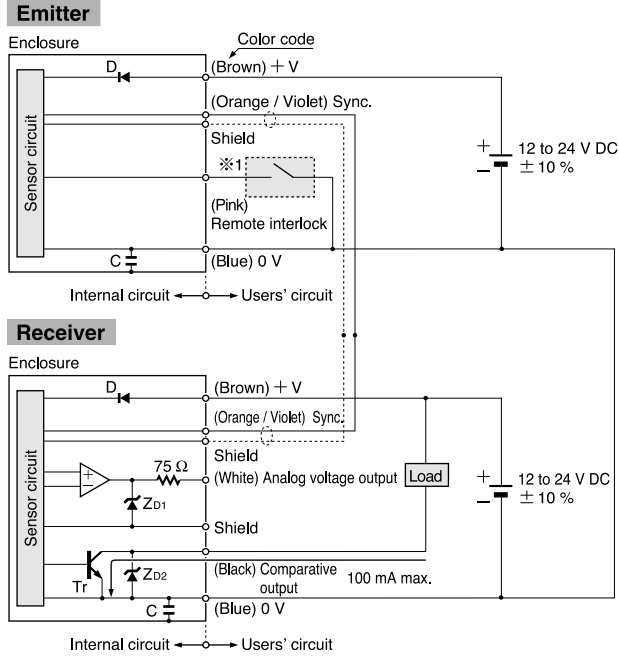

Symbols ... D: Reverse supply polarity protection diode
 Z_{D1}, Z_{D2}: Surge absorption zener diode
 C: Capacitor (0.022 μF)
 Tr: NPN output transistor

Wiring diagram

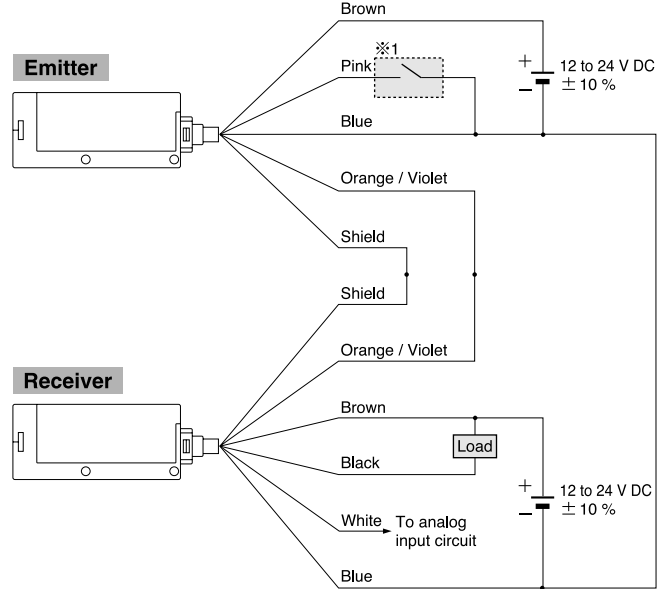

※1

Laser emission: Connection to 0 V
 Laser emission halt: Connection to + V, or open

Laser sensor controller

I/O circuit diagram

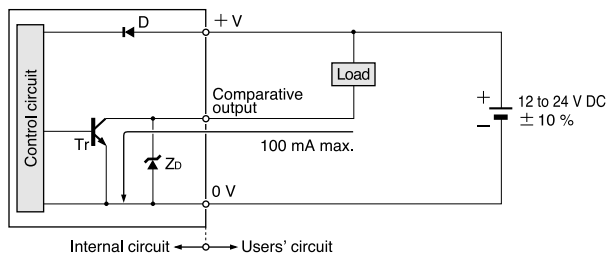

Symbols ... D: Reverse supply polarity protection diode
 Z_D: Surge absorption zener diode
 Tr: NPN output transistor

Auto-reference input circuit diagram

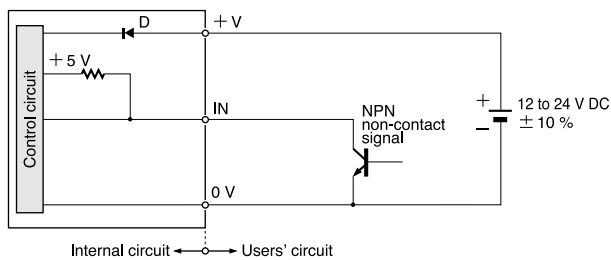

Symbol ... D: Reverse supply polarity protection diode

Wiring diagram

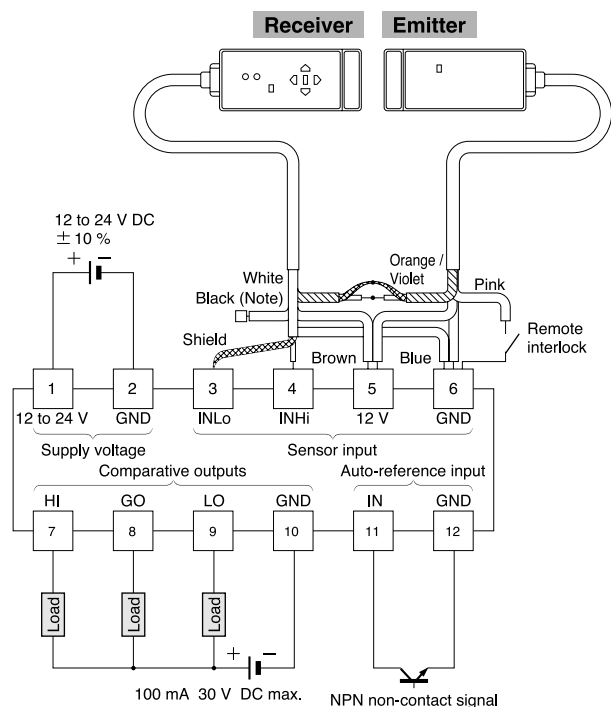

Note: In case the receiver's comparative output wire (black) is not used, please insulate it.

SENSING CHARACTERISTICS (TYPICAL)

Correlation between setting distance and excess gain

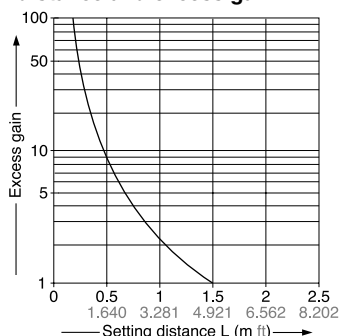

Correlation between transverse deviation and output voltage

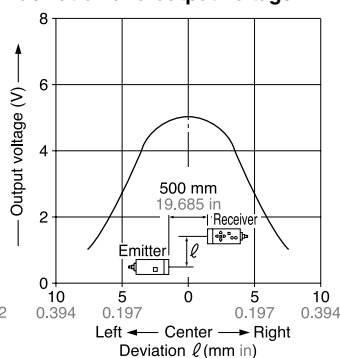

Correlation between interrupted beam width and output voltage

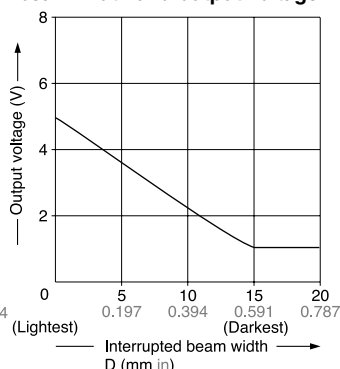

Correlation between ambient temperature and output voltage variation rate

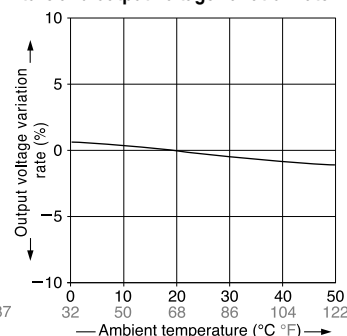

PRECAUTIONS FOR PROPER USE

Laser collimated beam sensor



This product is not a safety sensor. Its use is not intended or designed to protect life and prevent body injury or property damage from dangerous parts of machinery. It is a normal object detection sensor.



Safety measures for laser beam products

- The safety standard IEC Publication 825 specifies the application of laser beam products. Please read it carefully before using the laser beam sensor.
- Do not expose your eyes to the laser beam through optical instruments, like a lens.

Safety standards for laser beam products

- A laser beam can harm human being's eyes, skin, etc., because of its high energy density. IEC and JIS have classified laser products according to the degree of hazard and the stipulated safety requirements.

LA-510 and LA-511 are identified as a 'Class 1' laser products.

Class	Applicable model No.	Degree of danger
Class 1	LA-510 LA-511	Intrinsically safe design.
Class 2	—	Visible and low power (wavelength 400 to 700 nm 0.016 to 0.028 mil). Eyes react instinctively to laser beam and protect themselves.
Class 3A	—	Dangerous if eyes are exposed to laser beam through optical means. Visible beam should be 5 mW or less. Invisible beam should not exceed 5 times the Class 1 power.
Class 3B	—	Dangerous if eyes are exposed to laser beam directly. Unfocused, pulsed laser radiation 0.5 W or less can be observed by means of diffuse reflection.
Class 4	—	Too intense. Even diffuse reflection is possibly dangerous. It can burn the skin or cause a fire.

Mounting

- The emitter and the receiver must face each other with proper slit orientation so that the beam can be received.

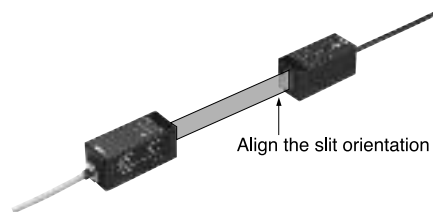

- The tightening torque should be 1.17 N·m or less. When mounting the sensor with the attached sensor mounting bracket, the sensor must be fixed on both sides.

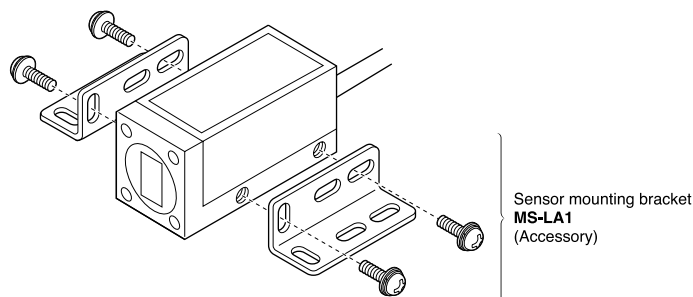

PRECAUTIONS FOR PROPER USE

Laser collimated beam sensor

Laser collimated beam alignment

- Place the emitter and the receiver so that they face each other along a straight line and align their positions until all yellow LEDs light off and the green LED lights up.

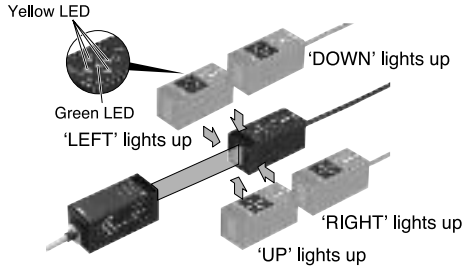

Span adjustment

- Turn the span adjuster until the analog voltage reaches + 5 V in the perfect light received condition (perfect beam alignment). As the span adjuster is turned clockwise, the analog voltage increases.

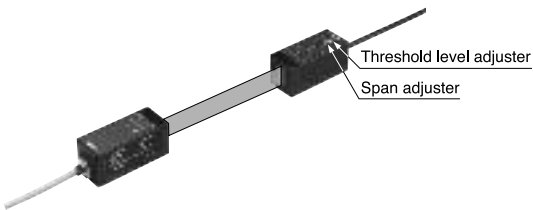

Threshold level adjustment

- The threshold level adjuster sets the threshold level of the comparative output. As the threshold adjuster is turned clockwise, the threshold level increases.

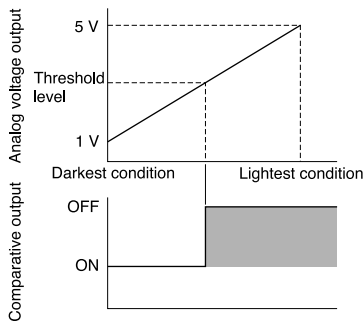

Wiring

- Make sure that the power supply is off while wiring.
- Verify that the supply voltage variation is within the rating.
- If power is supplied from a commercial switching regulator, ensure that the frame ground (F.G.) terminal of the power supply is connected to an actual ground.
- In this sensor, capacitor earth is used to enhance the noise characteristics. In case there is a high frequency noise generating equipment, such as, an ultrasonic welding machine, etc., near the sensor head and if the mounting base is electrically conducting (metallic, etc.), then insulate the sensor head from the mounting base.

Do not use a power supply having a single-winding transformer (auto-transformer) as this can be dangerous.

- In case noise generating equipment (switching regulator, inverter motor, etc.) is used in the vicinity of this product, connect the frame ground (F.G.) terminal of the equipment to an actual ground.
- Do not run the wires together with high-voltage lines or power lines or put them in the same raceway. This can cause malfunction due to induction.

Others

- The sensor's output is proportional to the amount of laser beam received. Since there is some variation in the light intensity at the center and the periphery of the sensing area, take care that 'output = dimension' may not hold.
- For stable operation, use the sensor 10 min., or more, after switching on the power supply.
- Avoid dust, dirt, and steam.
- Take care that the sensor does not come in direct contact with water, oil, grease, or organic solvents, such as, thinner, etc.

PRECAUTIONS FOR PROPER USE

Laser sensor controller

Threshold level setting

• Operation panel description

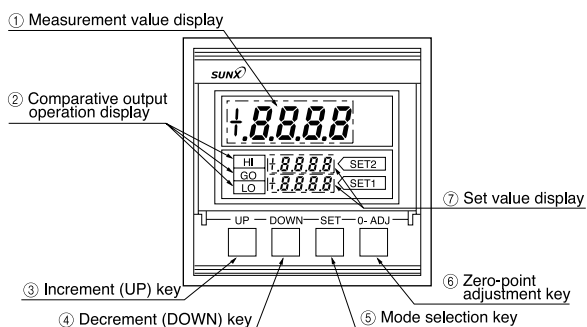

• Output mode

Two output modes are possible depending on the relative magnitudes of [SET 1] and [SET 2].

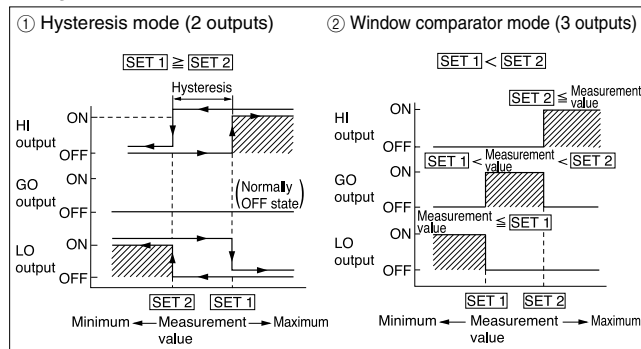

Note: In the window comparator mode, [SET 1] and [SET 2] should be separated by 2 digits or more.

• Setting method

[SET 1], [SET 2] setting modes and [Sensing mode] can be cyclically selected by pressing the [SET] key.

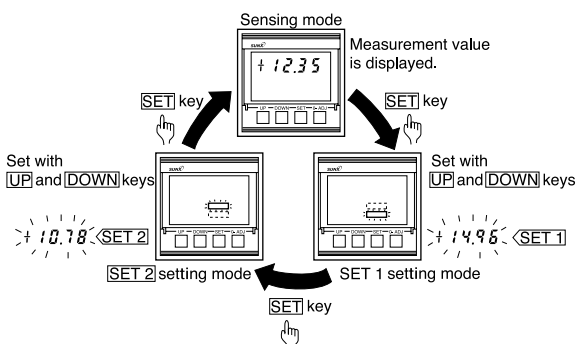

• Setting procedure

<Light width indication (indicated with '+')>

Step	Setting item	Display mode	Setting procedure
1	Zero-point adjustment	Sensing mode	Press the [0-ADJ] key under the Darkest condition (entire beam interrupted).
2	Full-scale adjustment	Sensing mode	Enter the sensor into the Lightest condition (entire beam is received). Turn the span adjuster until the displayed value becomes '+ 15.00'.
3	[SET 1] level setting	[SET 1] setting mode	Use [UP] and [DOWN] keys to set the level of [SET 1]. To increase the value, press the [UP] key. To decrease the value, press the [DOWN] key. + 19.99 + 19.98 ↑ [UP] + 0.00 - 19.98 ↓ [DOWN] - 19.99
4	[SET 2] level setting	[SET 2] setting mode	Set the level of [SET 2] with [UP] and [DOWN] keys.
5	—	Sensing mode	Press the [SET] key to complete the setting procedure.

<Interrupted beam width indication (indicated with '-')>

After completing Step 2 'Full-scale adjustment' given above, press the [0-ADJ] key again. The subsequent procedure is similar to that for 'Light width indication'.

Note: The output and operation display remain unchanged while [SET 1] or [SET 2] is adjusted.

★ If an error occurs, take the following corrective action.

Error code (Note 1)	Cause	Corrective action
Err 1	Short-circuit causing excess current flow.	Turn the power off and check the load.
Err 5	Set value exceeds the possible setting range (± 19.99) during the auto-reference input.	Check the set value.
- - - - (Note 2)	<ul style="list-style-type: none"> Input voltage exceeds 5.25 V. The measurement value exceeds the display range ($- 19.99$ to $+ 19.99$). 	<ul style="list-style-type: none"> The input voltage should not exceed 5.25 V. Keep the measurement value within the display range.

Notes: 1) The error code blinks in the measurement value display.
2) '- - - -' does not blink.
3) Please contact our office if 'Err 2' is displayed.

PRECAUTIONS FOR PROPER USE

Laser sensor controller

Auto-reference function

- The auto-reference function automatically shifts the set values to compensate for any change in the reference value at the time of auto-reference input.

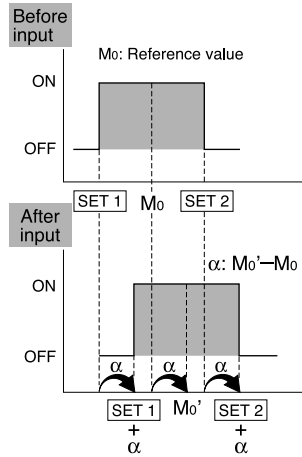

Time chart

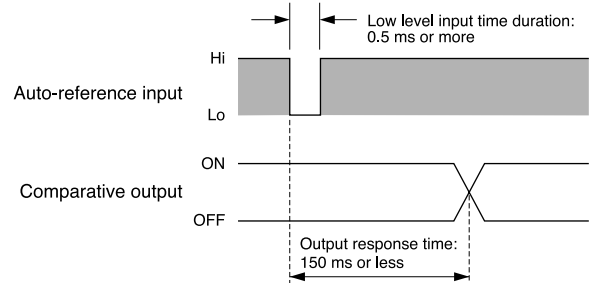

Note: Operation may be unstable (due to operation at the previous set values) for 150 ms immediately after the auto-reference input is applied.

Application example

Monitoring wire thickness

- Let the tolerance be ± 0.5 for a standard workpiece ($\phi 2$).

$$\text{Set: } \boxed{\text{SET 1}} = -0.5$$

$$\boxed{\text{SET 2}} = +0.5$$

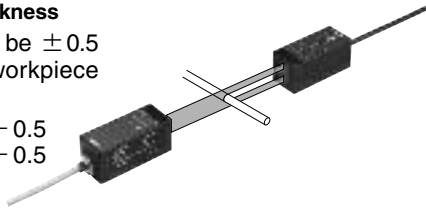

- Place the standard workpiece ($\phi 2$) within the sensing area and make the auto-reference input 'Low'. The set values get changed to

$$\boxed{\text{SET 1}} = 2 + (-0.5) = 1.5$$

$$\boxed{\text{SET 2}} = 2 + (+0.5) = 2.5$$

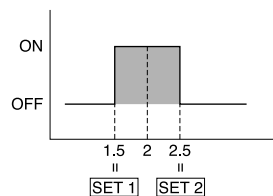

- In case the standard workpiece changes to $\phi 3$ and the tolerance is still ± 0.5 , place the standard workpiece ($\phi 3$) within the sensing area and make the auto-reference input 'Low'. The set values get changed to

$$\boxed{\text{SET 1}} = 3 + (-0.5) = 2.5$$

$$\boxed{\text{SET 2}} = 3 + (+0.5) = 3.5$$

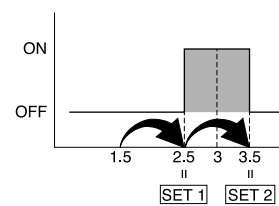

- In the sensing mode, the set values obtained after the auto-reference input are displayed. However, in the setting modes, the initial set values (in the application example, $\boxed{\text{SET 1}} = -0.5$ and $\boxed{\text{SET 2}} = +0.5$) are displayed.

Wiring

- Make sure that the power supply is off while wiring.
- Verify that the supply voltage variation is within the rating.
- If power is supplied from a commercial switching regulator, ensure that the frame ground (F.G.) terminal of the power supply is connected to an actual ground.
- In case noise generating equipment (switching regulator, inverter motor, etc.) is used in the vicinity of this product, connect the frame ground (F.G.) terminal of the equipment to an actual ground.
- Do not run the wires together with high-voltage lines or power lines or put them in the same raceway. This can cause malfunction due to induction.
- The tightening torque of screws on the terminal block should be 0.49 N·m or less.

Others

- Do not use during the initial transient time (1 sec.) after the power supply is switched on.
- Avoid applying an excess voltage (10 V or more) on the sensor input terminals, as it may cause malfunction.
- Avoid dust, dirt, steam, and corrosive gas.
- Take care that the controller does not come in direct contact with water, oil, grease, or organic solvents, such as, thinner, etc.

DIMENSIONS (Unit: mm in)

LA-510 LA-511

Laser collimated beam sensor

Emitter

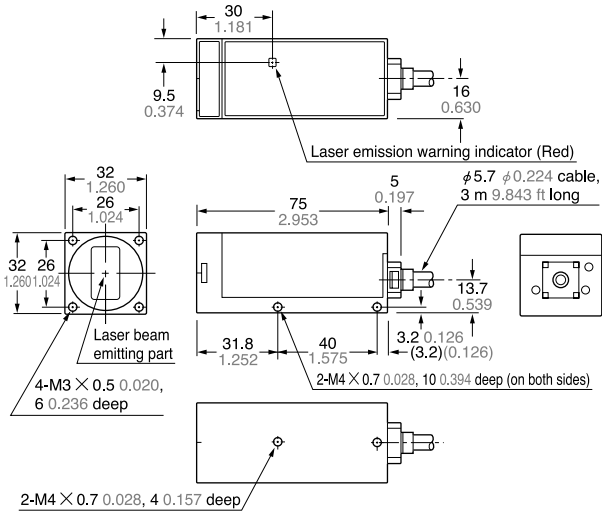

Receiver

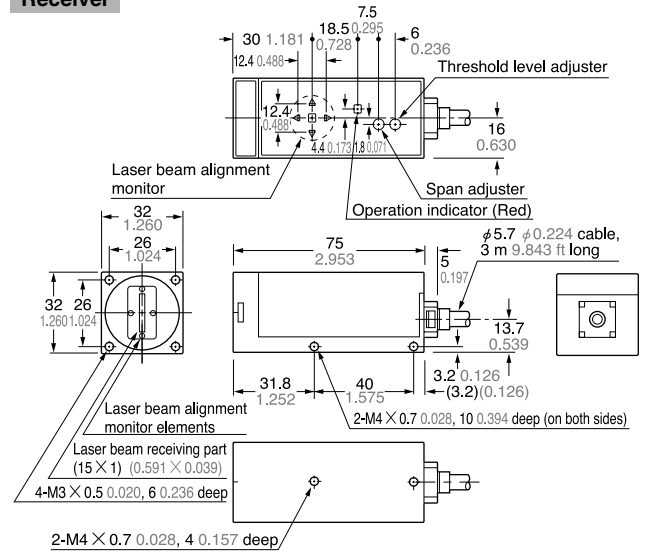

MS-LA1

Sensor mounting bracket (Accessory for LA-510 and LA-511)

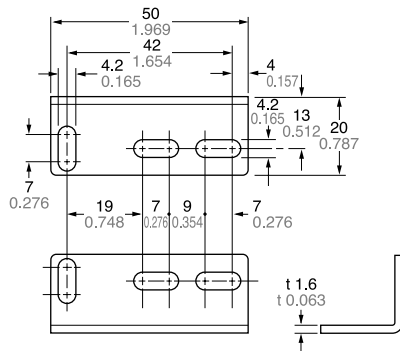

Material: Cold rolled carbon steel (SPCC)
(Uni-chrome plated)

Set of two L-shaped brackets and four
M4 (length 8 mm 0.315 in) screws with washers

Assembly dimensions

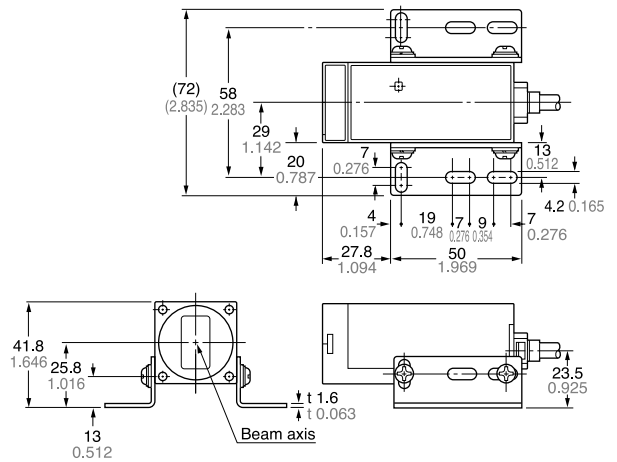

LA-SV1

Side view attachment (Optional)

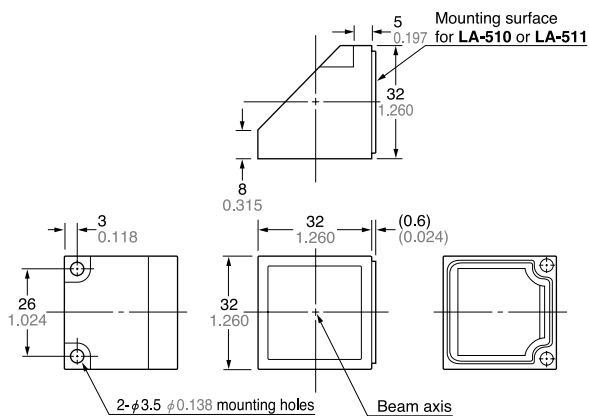

Material: Glass (Front protection cover, Aluminum evaporated mirror)
Polyetherimide (Enclosure)

Two M3 (length 10 mm 0.394 in) screws with washers are attached.

Assembly dimensions

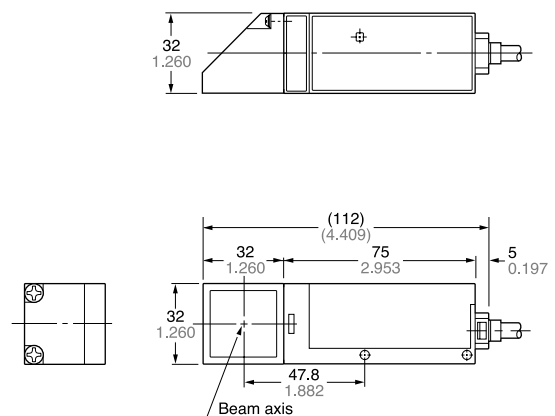

DIMENSIONS (Unit: mm in)

LA-C1

Laser sensor controller

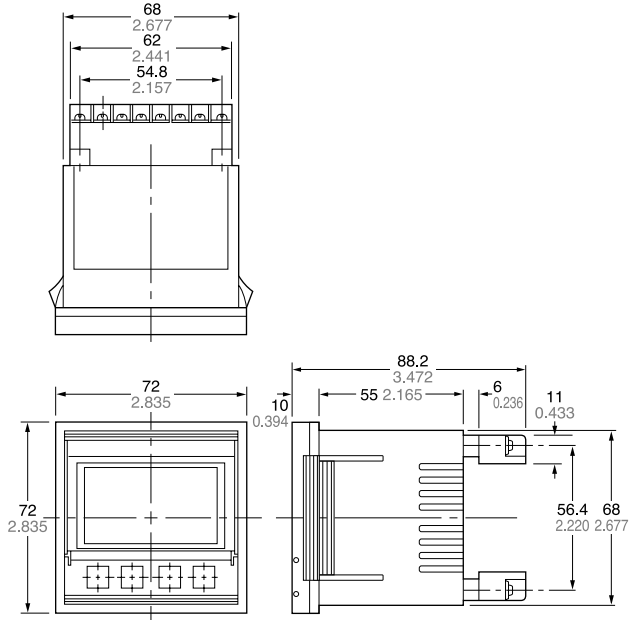

Panel cut-out dimensions

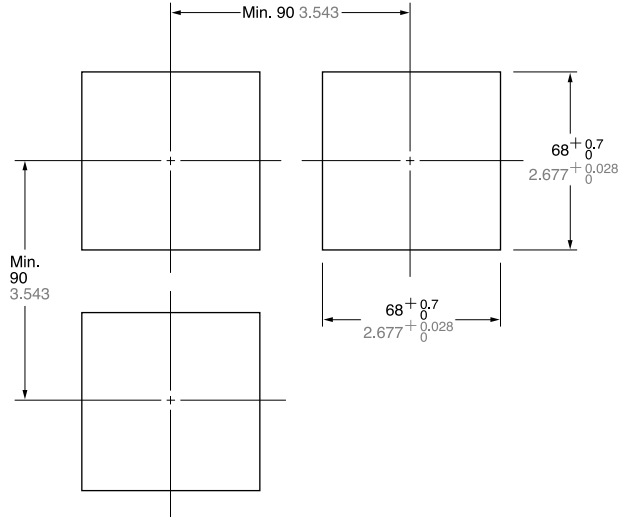

Note: The panel thickness should be 1 to 4 mm 0.039 to 0.157 in.